

Nettco S-Series Mixer

SANITARY STAINLESS STEEL - PORTABLE/FIXED MOUNT MIXERS



A World Leader in Industrial Mixing since 1923, Lightnin has 90 years of unrivaled experience in industrial mixing technology, process knowledge, and technological innovation. Lightnin enjoys a global reputation for durable, long-lasting mixers, agitators, aerators, and flocculators for fluid process systems. We offer a full spectrum of impeller designs for diverse applications. In addition, we offer a worldwide service network, mixer repair, gearbox repair, and replacement parts programs. Look to Lightnin for knowledge, technology, and service excellence.

SPX FLOW, Inc. (NYSE:FLOW) is a leading manufacturer of innovative flow technologies, many of which help define the industry standard in the market segments they serve. From its headquarters in Charlotte, North Carolina, it operates a sales and support network, centers of manufacturing excellence, and advanced engineering facilities, throughout the world. Its cutting-edge flow components and process equipment portfolio includes a wide range of pumps, valves, heat exchangers, mixers, homogenizers, separators, filters, UHT, and drying technology that meet many application needs. Its expert engineering capability also makes it a premium supplier of customized solutions and complete, turn-key packages to meet the most exacting of installation demands. Incorporating many leading brands, SPX FLOW has a long history of serving the food and beverage, power and energy, and industrial market sectors. Its designs and engineered solutions help customers drive efficiency and productivity, increase quality and reliability, and meet the latest regulatory demands. In-depth understanding of applications and processes, state-of-the-art Innovation Centers, and advanced pilot/testing technology further assist in optimizing processes and reducing timescales to reliably meet production targets. To learn more about SPX FLOW capabilities, its latest technology innovations and complete service offerings, please visit www.spxflow.com.

Introducing a new economical Portable and Fixed Mount Mixer System configured to meet your sanitary needs

MEETS 3A AND EC 1935:2004 STANDARDS FOR THE FOOD INDUSTRY

The Nettco S-Series sanitary mixer is available in a wide range of mixing and mounting configurations utilizing a unique modular assembly design. With one mixer it is possible to configure a clamp-on, open tank, or sealed mixer design. This mixer can be quickly converted from one mounting arrangement to another. Modifying the mounting configuration can be accomplished in less than two minutes.

- Highest quality at a competitive price
- For new and existing tank sizes: 0.1 - 20 m³ (25 - 5,000 U.S. gal.)
- Designed for Dairy, Beverage, Oil, Prepared Foods and more
- Wide range of impellers and mounting options



UNIQUE MODULAR CONCEPT FEATURES:

- Sanitary, all stainless steel design
 - 304 SS housing
 - Washdown (IP55), inverter ready motor
 - Proven planetary gearing – robust and reliable
 - Food grade lubricant
 - Unique, innovative modular design
 - Reverse-taper shaft attachment for added safety
 - Stainless Steel Motor, 0.37 - 2.2 Kw (1/2 - 3 HP)
 - Optional air motor available
 - Fully standardized product
- Direct and gear options for this global use mixer provides full range of shaft speeds (RPM)
 - 1450, 290, and 240 (50 Hz)
 - 1750, 350, and 280 (60 Hz)
- Shaft lengths up to 2100 mm (84")
- Simple, compact design, 3A and EC 1935:2004 clean design available
- Economical
- Impellers from world's mixing technology leader
 - Multiple style impellers available
 - Hydrofoil, PBT and FP 100 (Marine Props)

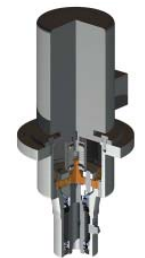

Gear Drive Section View



Direct Drive Section View



Air Motor

MODULAR DESIGN FEATURES:

Clamp Module (P):

- Bolted onto base module
- Clamps to vessel or stand
- 0° to 20° horizontal mounting
- 0° to 90° vertical adjustment

Adjustable mounting - controls vessel contents swirl for improved mixing



Fixed-Mount Open Tank Module (Q):

Open Tank Flange Module

- Attaches to base module
- Use on open tanks where a seal is not required
 - Vertical on center for baffled tanks
 - Vertical offset for unbaffled tanks
 - Can be angular mounted



Bung Adaptor

Allows for mixing in drums by fitting securely into the opening of the lid without the need for clamps or support brackets

- Attaches to base module
- For use on standard drum with a 2" NPT bung
- Stainless Steel construction to prevent corrosion



Fixed-Mount Closed Tank Lip Seal Module (L):

Closed Tank Sealed Module

- Attaches to base module
- For closed tanks with seal requirements
 - ANSI or DIN Flange Mount Lip Seal
 - Food grade lip seal good for 0.3 BAR (5 PSI) (allowable tank pressure)



Sanitary Flange Lip Seal:

Clamps to sanitary tank flanges for a simple, clean connection when a low pressure sealing device is required.

- Attaches to base module
- 3", 4" and 6" Sanitary Flange designs available
- Food grade lip seal good for 0.3 BAR (5 PSI) (allowable tank pressure)
- Stainless Steel construction to prevent corrosion



Fixed-Mount Closed Tank Mechanical Seal Module (S):

Closed Tank Sealed Module

- Attaches to base module
- For closed tanks with seal requirements
 - ANSI or DIN Flange Mount
 - Single dry-running mechanical seal good for 5 BAR (75 PSI) (allowable tank pressure)



Sanitary Flange Mechanical Seal Assembly:

Clamps to sanitary flanges for a simple, clean connection when a mechanical seal is required.

- Attaches to base module
- 3", 4" and 6" Sanitary Flange designs available
- Single dry-running mechanical seal good for 5 BAR (75 PSI) (allowable tank pressure)
- Stainless Steel construction to prevent corrosion



Typical product applications

With an all stainless steel construction and features designed to meet 3-A and EC 1935:2004 standards, the Nettco S-Series mixer can be used in a variety of sanitary mixing applications. And with Lightnin's unparalleled experience, every mixer comes with a process guarantee!

Dairy



Prepared Foods



Beverage



Pharma



Personal Care



MODULAR MIXING SYSTEM:

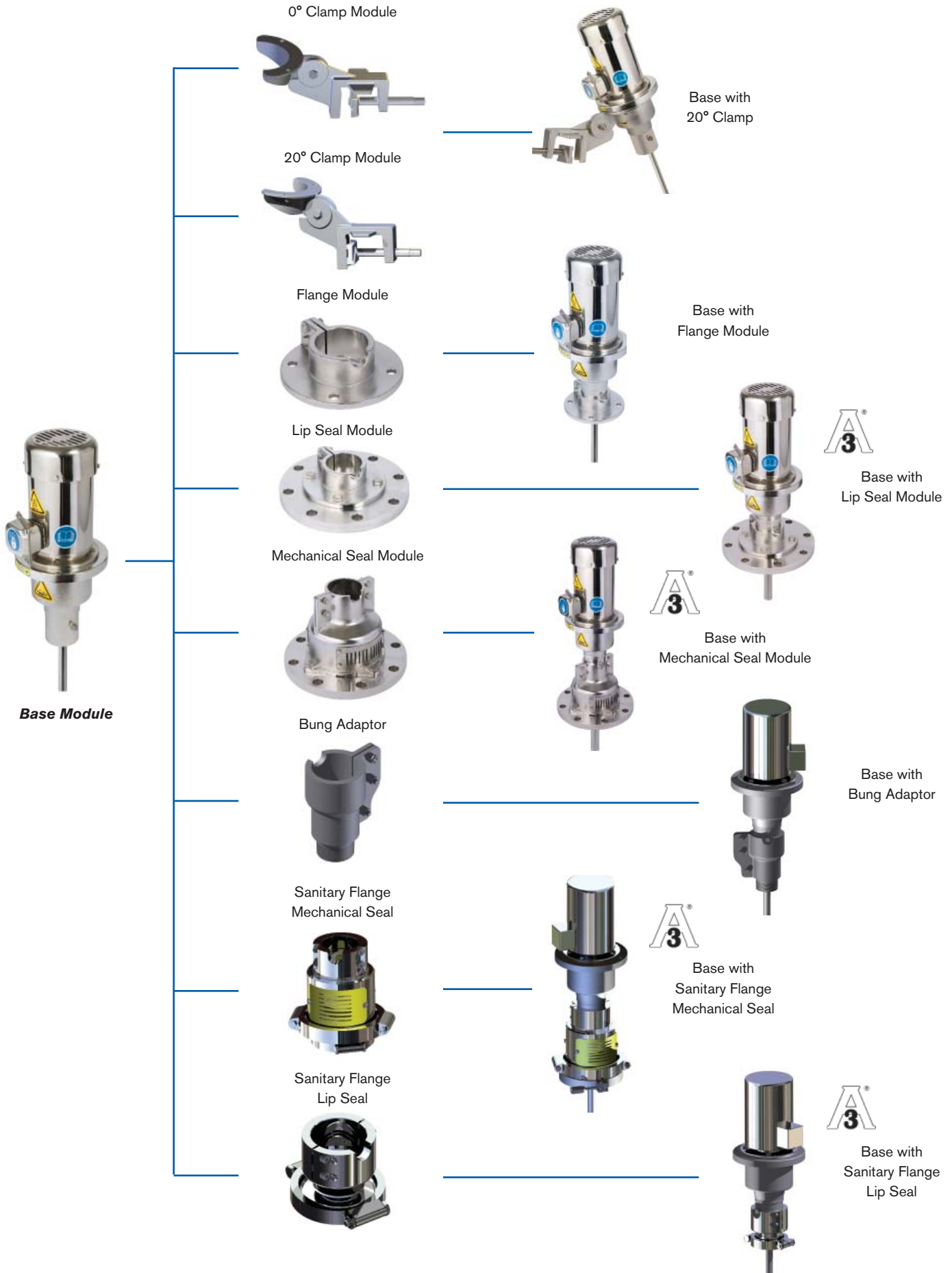

| MODEL | MOTOR | WEIGHT (SEE NOTE 3) | | A | C | D | E |
|-------|-----------|---------------------|-----|---------------|--------------|----|--------------|
| | | KG | LBS | | | | |
| MS_L1 | 0.37/0.50 | 36 | 80 | 464 (18.3) | 200 (7.9) | 20 | 105 (4.1) |
| MS_L2 | 0.55/0.75 | 54 | 120 | 699 (23.6) | | | 130 (5.1) |
| MS_L3 | 0.75/1.00 | 62 | 136 | 668 (24.3) | | | 138 (5.3) |
| MS_L4 | 1.10/1.50 | 69 | 153 | 672 (26.5) | | | 150 (5.9) |

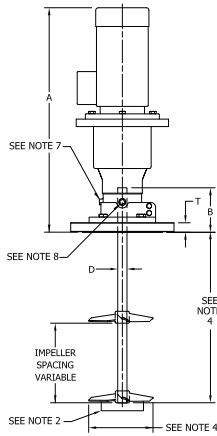
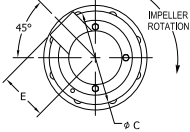

- NOTES:**
1. DIMENSIONS ARE FOR REFERENCE ONLY UNLESS CERTIFIED.
 2. LOWER IMPELLER IS EQUIPPED WITH STABILIZER WHEN REQUIRED.
 3. MIXER WEIGHT IS LESS SHAFT AND IMPELLERS.
 4. DEPENDENT UPON SPECIFIC APPLICATION.
 5. STANDARD MOUNTING FLANGE DATA, DIMENSIONS IN MILLIMETERS.
 6. STANDARD MOUNTING FLANGE DATA, DIMENSIONS IN INCHES.
 7. MIXER SHAFT SET SCREW ACCESS FOR MS_L1 UNITS IS ON CENTER WITH THE MIXER MOUNTING SPLIT LINE.
 8. MIXER SHAFT SET SCREW ACCESS FOR MS_L2 THRU MS_L6 UNITS.
 9. NON-STANDARD DIMENSIONS.
 10. FLANGE FINISH, INCLUDING GASKET AREA, IS POLISHED TO 20 Ra

| PN10 DRILLING (SEE NOTE 5) | | | | | | |
|----------------------------|------|-------------|--------------|-------------|-----|------|
| DN SIZE | O.D. | BOLT CIRCLE | NO. OF HOLES | BOLT DIA. Δ | B | T |
| 100 * | 229 | 180 | 8 | M16 | 128 | 33.8 |
| 125 | 250 | 210 | 8 | M16 | 112 | 17.7 |
| 150 | 285 | 240 | 8 | M20 | 112 | 17.7 |
| 200 | 340 | 295 | 12 | M20 | 116 | 21.7 |

| DAIRY FLANGE (SEE NOTES 5 & 9) | | | | | | |
|--------------------------------|------|-------------|--------------|-------------|-----|------|
| DN SIZE | O.D. | BOLT CIRCLE | NO. OF HOLES | BOLT DIA. Δ | B | T |
| 65* | 180 | 130 | 4 | M8 | 112 | 18.0 |

| 150LB. ANSI DRILLING (SEE NOTE 6) | | | | | | |
|-----------------------------------|------|-------------|--------------|-------------|-----|------|
| ANSI SIZE | O.D. | BOLT CIRCLE | NO. OF HOLES | BOLT DIA. Δ | B | T |
| 4 * | 9 | 7.50 | 8 | 0.63 | 5.0 | 1.33 |
| 5 | 10 | 8.50 | 8 | 0.75 | 4.5 | .77 |
| 6 | 11 | 9.50 | 8 | 0.75 | 4.5 | .83 |
| 8 | 13.5 | 11.75 | 8 | 0.75 | 4.6 | .96 |

Δ BOLT HOLES STRADDLE MIXER CENTERLINE.
* FLANGE SIZES ONLY AVAILABLE ON MS_L1 UNITS.

L UNIT

| MODEL | MOTOR | WEIGHT (SEE NOTE 3) | | A | B | C | D | E | | F | | G | | H | | | L | M | N | O | | |
|-------|-----------|---------------------|-----|---------------|-------------|--------------|--------------|-------------|-------------|-------------|-------------|--------------|--------------|-------------|-------------|-------------|--------------|--------------|---------------|--------------|--------------|--------------|
| | | KG | LBS | | | | | Max | Offset | Offset | Offset | Offset | Offset | Offset | | | | | | | | |
| | | α | α | | | | | α | α | α | α | α | α | α | | | | | | | | |
| MS_P1 | 0.37/0.50 | 24 | 52 | 312 (12.3) | 89 (3.5) | 200 (7.9) | 123 (4.8) | 67 (2.6) | 73 (2.9) | 37 (1.5) | 45 (1.8) | 111 (4.4) | 119 (4.7) | 65 (2.6) | 28 (1.1) | 45 (1.8) | 129 (5.1) | 113 (4.5) | 235 (9.3) | 82 (3.2) | 105 (4.1) | |
| MS_P2 | 0.55/0.75 | 45 | 99 | | | | | | | | | | | | | | | | | | 130 (5.1) | |
| MS_P3 | 0.75/1.00 | 52 | 115 | 411 (16.2) | 89 (3.5) | 250 (9.8) | 147 (5.8) | 84 (3.3) | 77 (3.0) | 46 (1.8) | 60 (2.4) | 138 (5.4) | 152 (6.0) | 85 (3.3) | 33 (1.3) | 49 (1.9) | 176 (6.9) | 159 (6.3) | 260 (10.2) | 103 (4.1) | 25 (1.0) | |
| MS_P4 | 1.10/1.50 | 60 | 132 | | | | | | | | | | | | | | | | | | 138 (5.3) | |
| MS_P5 | 1.50/2.00 | | | | | | | | | | | | | | | | | | | | | 150 (5.9) |
| MS_P6 | 2.20/3.00 | | | | | | | | | | | | | | | | | | | | | |

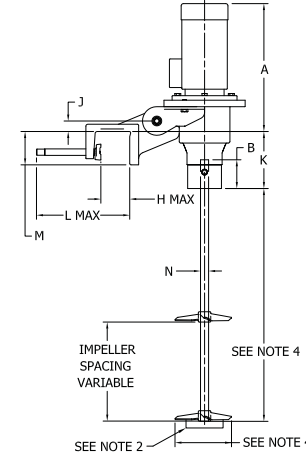
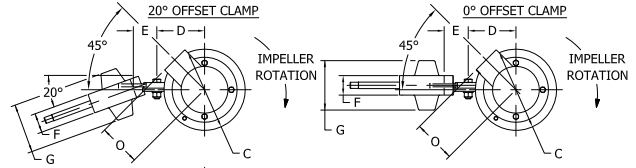

- NOTES:**
1. DIMENSIONS ARE FOR REFERENCE ONLY UNLESS CERTIFIED.
 2. LOWER IMPELLER IS EQUIPPED WITH STABILIZER WHEN REQUIRED.
 3. MIXER WEIGHT IS LESS SHAFT AND IMPELLERS.
 4. DEPENDENT UPON SPECIFIC APPLICATION.

P UNIT

| MODEL | MOTOR | WEIGHT (SEE NOTE 3) | | A | B | C | D | E | F | G | H | J |
|-------|-----------|---------------------|-----|---------------|-------------|--------------|-------------|--------------|--------------|----|----|--------------|
| | | KG | LBS | | | | | | | | | |
| MS_Q1 | 0.37/0.50 | 21 | 47 | 429 (16.9) | 94 (3.7) | 200 (7.9) | 51 (2.0) | 102 (4.0) | 180 (7.1) | 10 | 20 | 105 (4.1) |
| MS_Q2 | 0.55/0.75 | 40 | 89 | | | | | | | | | 130 (5.1) |
| MS_Q3 | 0.75/1.00 | 48 | 105 | 575 (22.6) | 94 (3.7) | 250 (9.8) | 51 (2.0) | 102 (4.0) | 180 (7.1) | 15 | 25 | 135 (5.3) |
| MS_Q4 | 1.10/1.50 | 55 | 122 | | | | | | | | | 150 (5.9) |

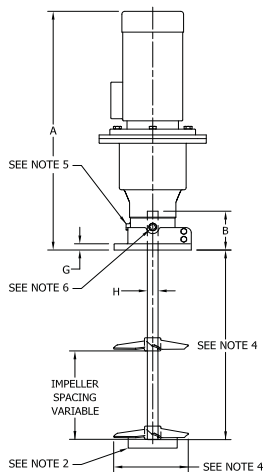
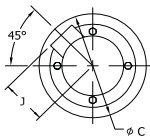

4 Ø13 (0.5) MOUNTING HOLES
MOUNTING HOLE DATA

- NOTES:**
1. DIMENSIONS ARE FOR REFERENCE ONLY UNLESS CERTIFIED.
 2. LOWER IMPELLER IS EQUIPPED WITH STABILIZER WHEN REQUIRED.
 3. MIXER WEIGHT IS LESS SHAFT AND IMPELLERS.
 4. DEPENDENT UPON SPECIFIC APPLICATION.
 5. MIXER SHAFT SET SCREW ACCESS FOR MS_Q1 UNITS IS ON CENTER WITH THE MIXER MOUNTING SPLIT LINE.
 6. MIXER SHAFT SET SCREW ACCESS FOR MS_Q2 THRU MS_Q6 UNITS.

| MODEL | MOTOR | WEIGHT (SEE NOTE 3) | | A | C | D | E |
|-------|-----------|---------------------|-----|---------------|--------------|----|--------------|
| | | KG | LBS | | | | |
| MS_S1 | 0.37/0.50 | 40 | 87 | 577 (22.7) | 200 (7.9) | 20 | 105 (4.1) |
| MS_S2 | 0.55/0.75 | 57 | 126 | 699 (27.5) | | | 130 (5.1) |
| MS_S3 | 0.75/1.00 | 64 | 142 | 768 (30.2) | | | 138 (5.3) |
| MS_S4 | 1.10/1.50 | 72 | 159 | 772 (30.4) | | | 150 (5.9) |

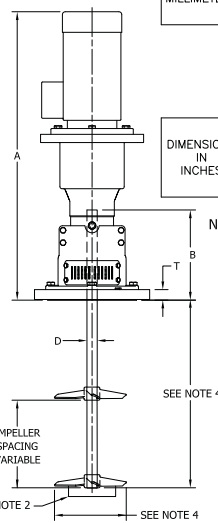
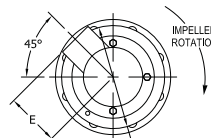

| DN SIZE | O.D. | BOLT CIRCLE | NO. OF HOLES | BOLT DIA. Δ | B | | T |
|---------|------|-------------|--------------|-------------|-------|------------------|------|
| | | | | | MS_S1 | MS_S2 THRU MS_S6 | |
| 100 * | 229 | 180 | 8 | M16 | 241 | N/A | 33.8 |
| 125 | 250 | 210 | 8 | M16 | 225 | 212 | 17.7 |
| 150 | 285 | 240 | 8 | M20 | 225 | 212 | 17.7 |
| 200 | 340 | 295 | 12 | M20 | 229 | 216 | 21.7 |

| ANSI SIZE | O.D. | BOLT CIRCLE | NO. OF HOLES | BOLT DIA. Δ | B | | T |
|-----------|------|-------------|--------------|-------------|-------|------------------|------|
| | | | | | MS_S1 | MS_S2 THRU MS_S6 | |
| 4 * | 9 | 7.50 | 8 | 0.63 | 9.5 | N/A | 1.33 |
| 5 | 10 | 8.50 | 8 | 0.75 | 8.9 | 8.4 | .77 |
| 6 | 11 | 9.50 | 8 | 0.75 | 9.0 | 8.5 | .83 |
| 8 | 13.5 | 11.75 | 8 | 0.75 | 9.1 | 8.6 | .96 |

Δ BOLT HOLES STRADDLE MIXER CENTERLINE.
* FLANGE SIZES ONLY AVAILABLE ON MS_S1 UNITS

- NOTES:**
1. DIMENSIONS ARE FOR REFERENCE ONLY UNLESS CERTIFIED.
 2. LOWER IMPELLER IS EQUIPPED WITH STABILIZER WHEN REQUIRED.
 3. MIXER WEIGHT IS LESS SHAFT AND IMPELLERS.
 4. DEPENDENT UPON SPECIFIC APPLICATION.
 5. STANDARD MOUNTING FLANGE DATA, FLANGE FACE, INCLUDING GASKET AREA, IS POLISHED TO 20Ra

Q UNIT

S UNIT

MIXER "BLEND TIME SELECTION TABLE"

60 HZ SELECTIONS

| | | VISCOSITY/cP or mPa-s | | | | | | |
|----------------------------|--------|---------------------------|---------------------------|---------------------------|---------------------------|---------------------------|---------------------------|----------------------------|
| | | 1 | 100 | 250 | 500 | 1000 | 2500 | 5000 |
| TANK VOLUME / U.S. GALLONS | < 25 | MS1_1 (1) 1 3.6 FP | MS1_1 (1) 1 3.6 FP | MS1_1 (1) 1 3.6 FP | MS1_1 (1) 1 3.6 FP | MS1_1 (1) 1 3.3 FP | MS6_1 (2) 1 8.9 FP | MS6_1 (3) 1 7.7 FP |
| | < 50 | MS1_1 (1) 1 3.6 FP | MS1_1 (1) 1 3.6 FP | MS1_1 (2) 1 3.6 FP | MS1_1 (2) 1 3.6 FP | MS5_1 (1) 1 10.0 H | MS6_1 (3) 1 8.9 FP | MS6_1 (3) 1 10.0 FP |
| | < 100 | MS1_1 (2) 1 3.6 FP | MS1_1 (2) 1 3.6 FP | MS1_1 (2) 1 3.8 FP | MS5_1 (1) 1 11.2 H | MS5_1 (2) 1 10.0 H | MS6_1 (3) 1 10.0 FP | MS6_2 (5) 2 10.0 FP |
| | < 200 | MS1_1 (3) 1 3.6 FP | MS1_1 (3) 1 3.6 FP | MS5_1 (1) 1 11.2 H | MS5_1 (2) 1 11.2 H | MS6_1 (3) 2 11.2 H | MS6_2 (6) 2 10.5 FP | MS6_3 (9) 2 10.5 FP |
| | < 500 | MS1_1 (6) 1 3.8 H | MS5_1 (3) 1 11.2 H | MS5_1 (4) 1 11.2 H | MS5_1 (5) 1 11.8 H | MS6_1 (6) 2 12.8 H | MS6_3 (12) 2 13.6 H | MS6_4 (11) 2 11.4 FP |
| | < 1000 | MS5_1 (4) 1 11.2 H | MS5_1 (7) 1 11.2 H | MS5_1 (6) 1 11.8 H | MS5_1 (7) 1 12.8 H | MS6_2 (10) 1 13.6 H | MS6_3 (21) 2 13.6 H | MS6_5 (15) 2 13.1 FP |
| | < 2000 | MS5_1 (7) 1 11.2 H | MS5_1 (14) 1 11.2 H | MS6_1 (12) 2 12.8 H | MS6_2 (17) 2 13.6 H | MS6_3 (22) 2 14.5 H | MS6_4 (33) 2 15.1 H | |
| | < 3000 | MS6_1 (11) 2 11.8 H | MS6_1 (16) 2 12.8 H | MS6_2 (18) 2 13.6 H | MS6_3 (20) 2 14.5 H | MS6_4 (27) 2 15.1 H | MS6_5 (42) 2 15.6 H | |
| | < 5000 | MS6_1 (14) 2 12.8 H | MS6_2 (23) 2 13.6 H | MS6_3 (24) 2 14.5 H | MS6_4 (27) 2 15.1 H | MS6_4 (38) 2 15.1 H | | |

Legend:

| Series | Drive Ratio | Mounting | Motor Code | HP/kW |
|-----------|-------------|----------|------------|------------------|
| Nettco MS | 1 | P | 1 | (0.5/0.37) |
| | 5 | Q | 2 | (0.75/.055) |
| | 6 | L | 3 | (1/0.75) |
| | | S* | 4 | (1.5/1.1) |
| | | | 5 | (2/1.5) |
| | | | 6 | (3/2.2) |
| | | | 8** | (0.5/.37) |
| | | | 9** | (0.75-2/.55-1.5) |
| | | | 10** | (3/2.2) |

Tank height to diameter ratio 0.8 - 1.2

Liquids with Newtonian viscosity characteristics

S.G. difference of liquids < 0.1

Use for mild blending applications

Maximum density 1.10 g/cm³

Maximum viscosity ratio - 10:1 (>250cP)

Mixer in operation during filling and emptying

Example: Mi1Q2

*Direct Drive not available with seal.

** Air Motors

Chart Reference:

| Model Design | | |
|-------------------|---------------------|---------------|
| Blend Time (min.) | | |
| No. Impeller | Impeller Dia. (in.) | Impeller Type |

FP = FP-100, H = Hydrofoil

MIXER “BLEND TIME SELECTION TABLE”

50 HZ SELECTIONS

| | | VISCOSITY/cP or mPa-s | | | | | | |
|----------------------------|---------|--------------------------|--------------------------|--------------------------|--------------------------|--------------------------|--------------------------|---------------------------|
| | | 1 | 100 | 250 | 500 | 1000 | 2500 | 5000 |
| TANK VOLUME /LITERS | < 100 | MS1_1 (1) 1 104 FP | MS1_1 (1) 1 104 FP | MS1_1 (1) 1 104 FP | MS1_1 (1) 1 104 FP | MS1_1 (1) 1 97 FP | MS5_1 (2) 1 254 FP | MS5_1 (2) 1 226 FP |
| | < 250 | MS1_1 (1) 1 104 FP | MS1_1 (1) 1 104 FP | MS1_1 (2) 1 104 FP | MS1_1 (2) 1 104 FP | MS5_1 (1) 1 325 H | MS5_1 (3) 1 254 FP | MS5_1 (3) 1 239 FP |
| | < 500 | MS1_1 (2) 1 104 FP | MS1_1 (2) 1 104 FP | MS5_1 (1) 1 325 H | MS5_1 (1) 1 325 H | MS5_1 (3) 2 285 H | MS5_2 (4) 2 239 FP | MS5_2 (5) 2 226 FP |
| | < 1000 | MS1_1 (4) 1 104 FP | MS5_1 (2) 1 325 H | MS5_1 (2) 1 325 H | MS5_1 (2) 1 325 H | MS5_1 (5) 2 285 H | MS5_3 (7) 2 325 H | MS5_3 (7) 2 239 FP |
| | < 1500 | MS1_1 (5) 1 104 FP | MS5_1 (3) 1 325 H | MS5_1 (3) 1 325 H | MS5_1 (3) 1 325 H | MS5_1 (7) 2 285 H | MS5_3 (10) 2 325 H | MS5_3 (9) 2 239 FP |
| | < 2000 | MS1_1 (7) 1 104 FP | MS5_1 (3) 1 325 H | MS5_1 (4) 1 325 H | MS5_1 (5) 1 325 H | MS5_1 (8) 2 285 H | MS5_3 (12) 2 325 H | MS5_4 (11) 2 267 FP |
| | < 2500 | MS5_1 (3) 1 325 H | MS5_1 (5) 1 325 H | MS5_1 (5) 1 325 H | MS5_1 (5) 1 325 H | MS5_2 (7) 1 368 H | MS5_3 (16) 2 325 H | MS5_5 (11) 2 290 FP |
| | < 3750 | MS5_1 (4) 1 325 H | MS5_1 (7) 1 325 H | MS5_1 (6) 1 325 H | MS5_1 (7) 1 325 H | MS5_2 (10) 1 368 H | MS5_3 (21) 2 325 H | MS5_5 (15) 2 290 FP |
| | < 5000 | MS5_1 (5) 1 325 H | MS5_1 (9) 1 325 H | MS5_1 (9) 2 300 H | MS5_2 (13) 2 325 H | MS5_3 (14) 2 345 H | MS5_4 (26) 2 345 H | |
| | < 7500 | MS5_1 (6) 1 325 H | MS5_1 (14) 1 325 H | MS5_1 (13) 2 300 H | MS5_2 (17) 2 325 H | MS5_3 (23) 2 345 H | MS5_4 (37) 2 345 H | |
| | < 10000 | MS5_1 (8) 1 325 H | MS5_1 (17) 2 300 H | MS5_2 (14) 2 325 H | MS5_3 (18) 2 25 H | MS5_4 (24) 2 368 H | MS5_5 (37) 2 384 H | |
| | < 12500 | MS5_1 (11) 2 300 H | MS5_2 (17) 2 325 H | MS5_3 (18) 2 325 H | MS5_4 (20) 2 384 H | MS5_4 (28) 2 368 H | | |
| | < 15000 | MS5_1 (12) 2 300 H | MS5_2 (21) 2 325 H | MS5_3 (20) 2 325 H | MS5_4 (22) 2 384 H | MS5_4 (32) 2 368 H | | |
| | < 20000 | MS5_1 (16) 2 300 H | MS5_2 (27) 2 325 H | MS5_3 (23) 2 325 H | | | | |

Chart Reference:

| | | |
|-------------------|--------------------------|------------------|
| Model Design | | |
| Blend Time (min.) | | |
| No. Impeller | Impeller Dia. (mm) | Impeller Type |

FP = FP-100, H = Hydrofoil

Nettco S-Series Mixers

**SANITARY STAINLESS
STEEL PORTABLE/FIXED
MOUNT MIXERS**

SPXFLOW

MULTIPLE IMPELLER STYLES:



PBT Impeller:

For low-to-medium viscosity flow controlled applications. Although superseded by the Hydrofoil, the PBT still has a specific role in applications where a degree of fluid shear is beneficial to the overall process result.



FP 100 Impeller (Marine Prop):

Recommended for applications requiring moderate pumping action and powder-wetting capabilities.



Hydrofoil Impeller:

For low viscosity flow controlled applications. Combines performance and high flow efficiency not found in other axial flow impellers.

GEAR DRIVE MIXER REPAIR KIT:

- Service kits available for rapid replacement of routine service items.

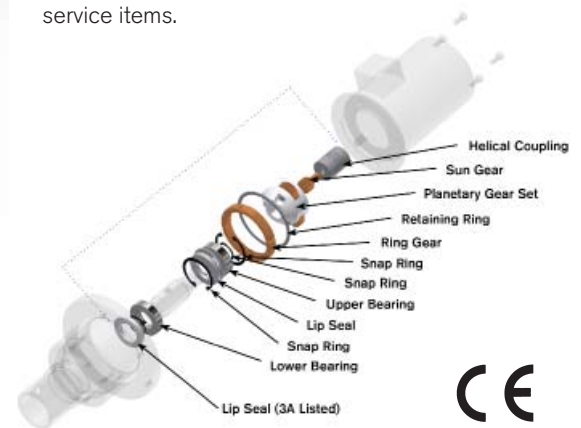

SPX FLOW, Inc. - Global locations

USA

13320 Ballantyne Corporate Place
Charlotte, NC 28277
United States of America
+1 704 752 4400

CHINA

2F, Treasury Centre
No. 1568 Huashan Road
Shanghai 200052, China
P: +86 (21) 22085889

UK

Ocean House,
Towers Business Park
Didsbury, Manchester
M20 2LY, UK
P: +44 161 249 1170

SPX FLOW, LLC - LIGHTNIN & PLENTY MIXERS

135 Mt. Read Blvd.
Rochester, NY 14611
P: (888) 649-2378 (MIX-BEST), US and Canada) or +1 (585) 436-5550
F: (585) 436-5589
E: lightnin@spx.com ▪ www.spxflow.com/lightnin

SPX FLOW, Inc. reserves the right to incorporate our latest design and material changes without notice or obligation.

Design features, materials of construction, and dimensional data, as described in this bulletin, are provided for your information only and should not be relied upon unless confirmed in writing. Please contact your local sales representative for product availability in your region. For more information, visit www.spxflow.com.

The green ">" is a trademark of SPX FLOW, Inc.

ISSUED 11/2015 B-933

COPYRIGHT © 2015 SPX FLOW, Inc.

For other Sales locations, click

www.lightninmixers.com/contacts/where-to-buy/

or use your SmartPhone and the QR Code.

